

IMM Sample Projects - 2018

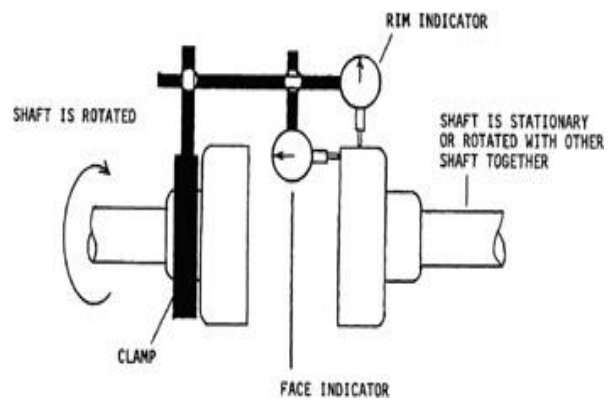

Example of Coupling / Shaft Alignment Project Dial Indicator or Laser (Fixturlaser NXA Pro) alignment equipment will be used by the competitor to complete the above task.

All of the above are samples of the type of work you will be required to complete during the Skills Ontario IMM Competition 2018.

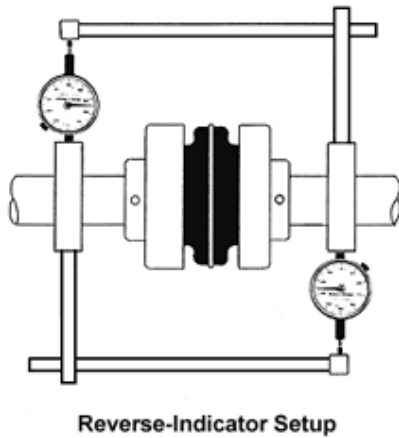
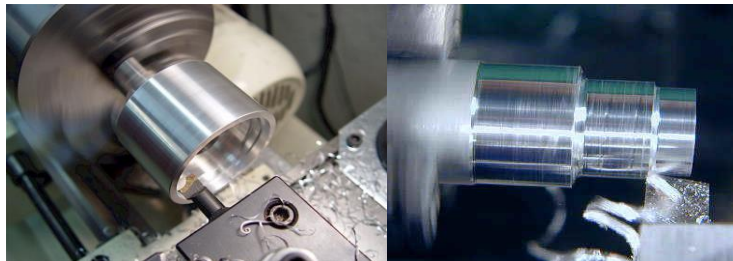
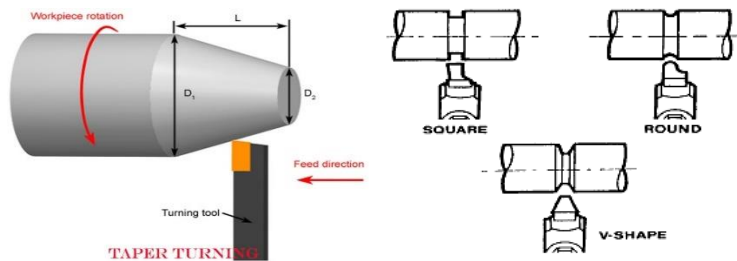
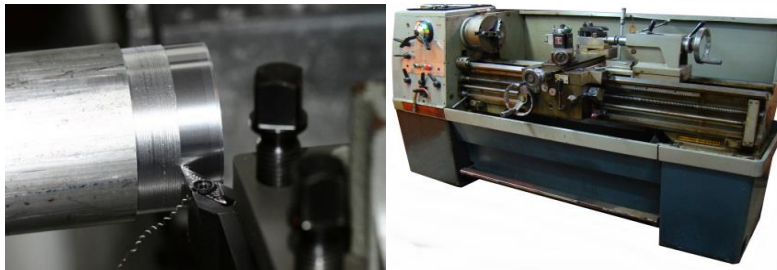

An Example of a Centre Lathe and potential machining set-ups that may be used by the competitor for the machining portion of the competition.

All of the above are samples of the type of work you will be required to complete during the Skills Ontario IMM Competition 2018.

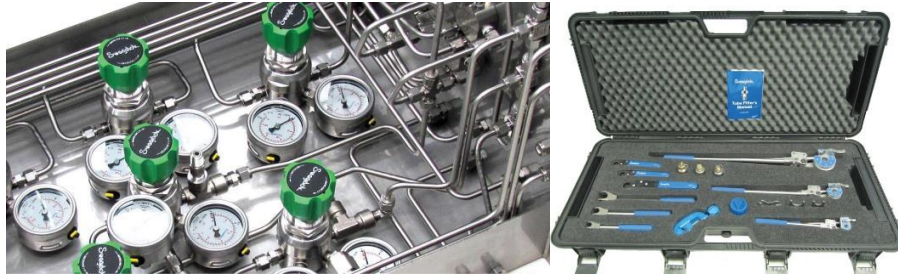

Examples of “Swagelok” Tube Bending Tools that will be used by the competitor to complete the Stainless Steel Tube Bending Project.



Example of Festo Didactic components that competitors will use to design, build and troubleshoot a Multi Cylinder Sequential or Cascade Circuit.

All of the above are samples of the type of work you will be required to complete during the Skills Ontario IMM Competition 2018.

SECTIONAL DRAWING AND COMPONENTS LIST

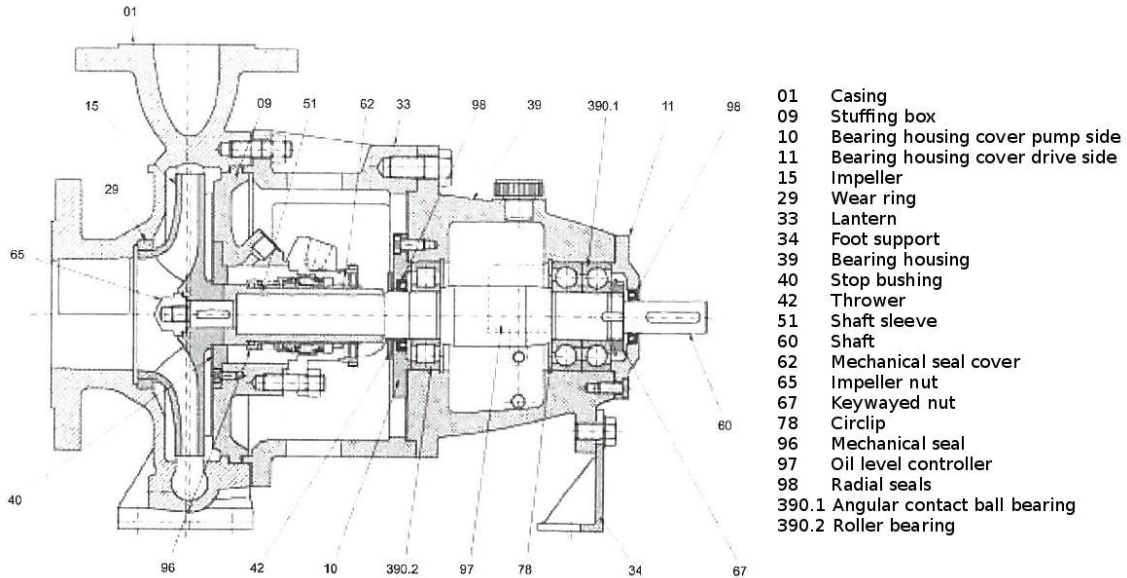

Coro-Vane® Pump (Sliding Vane)

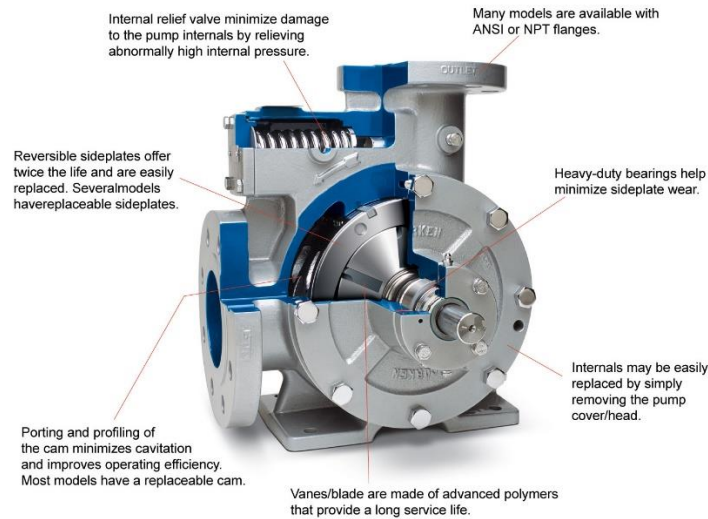

An Example of a Centrifugal & Positive Displacement Pump that may be used in this part of the competition.

All of the above are samples of the type of work you will be required to complete during the Skills Ontario IMM Competition 2018.