

TOP COLLAR / DESSUS DE COL

I I

I I

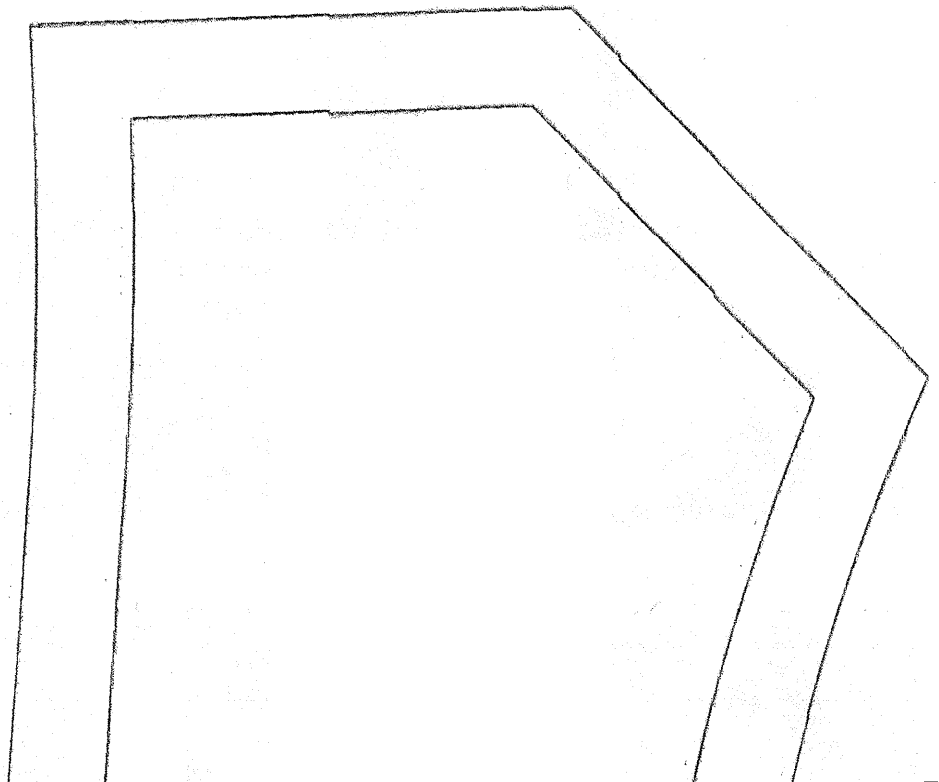







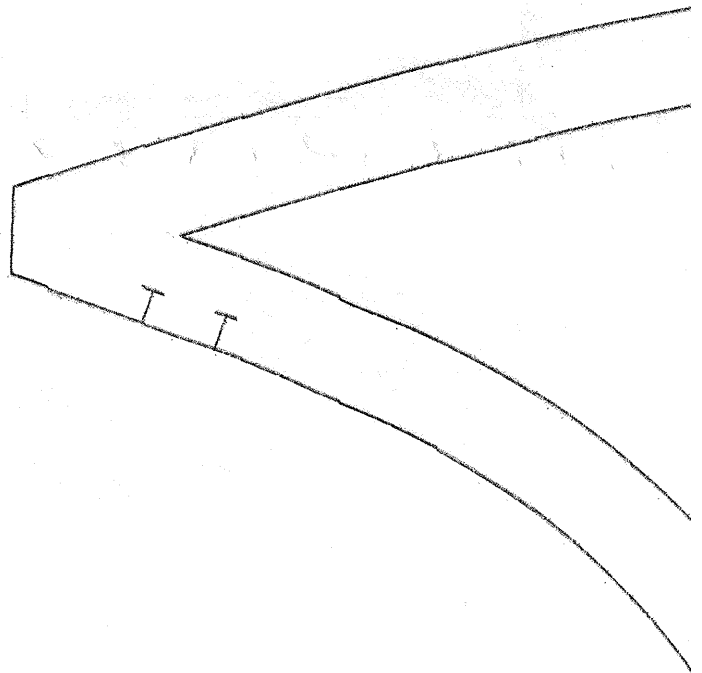
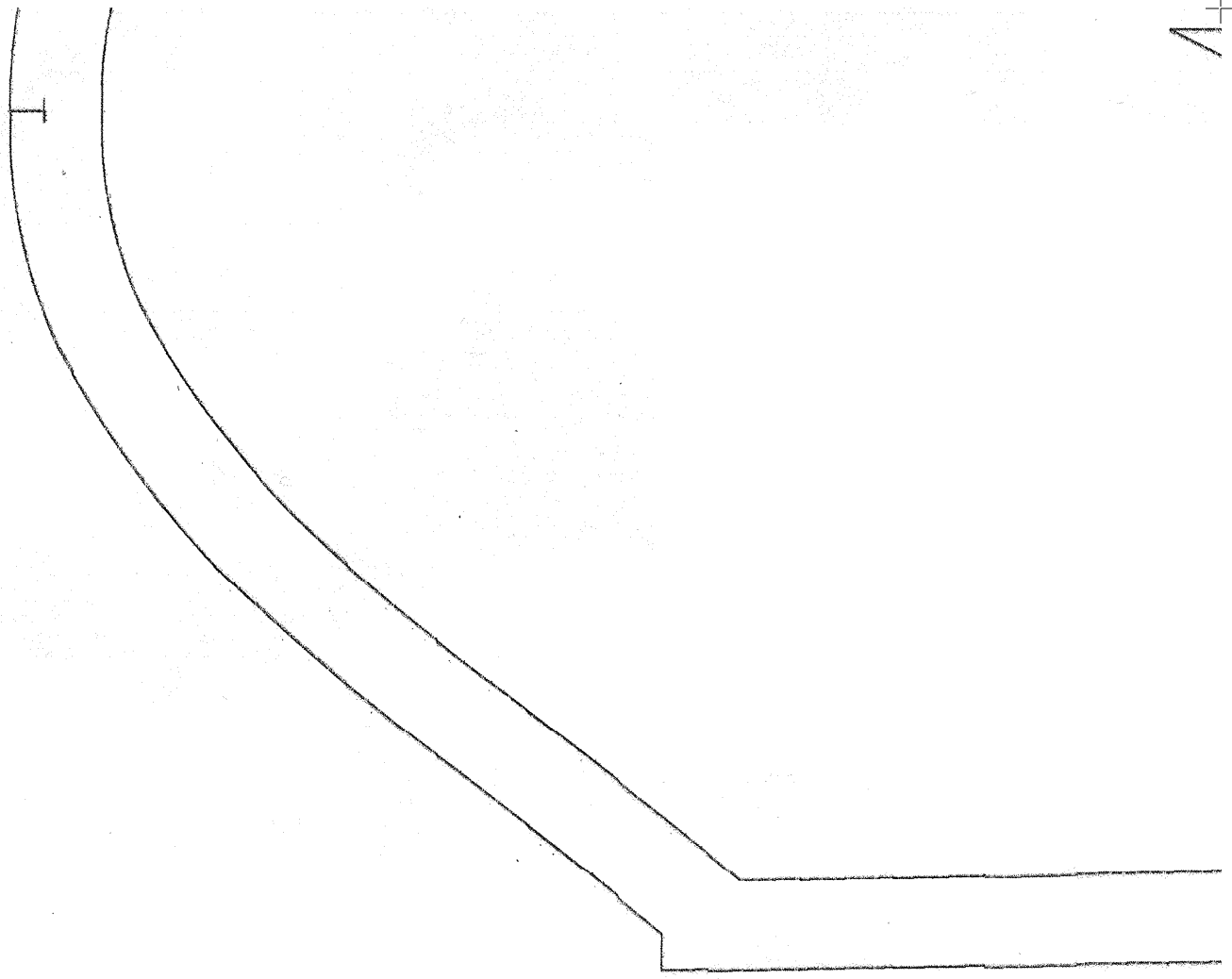

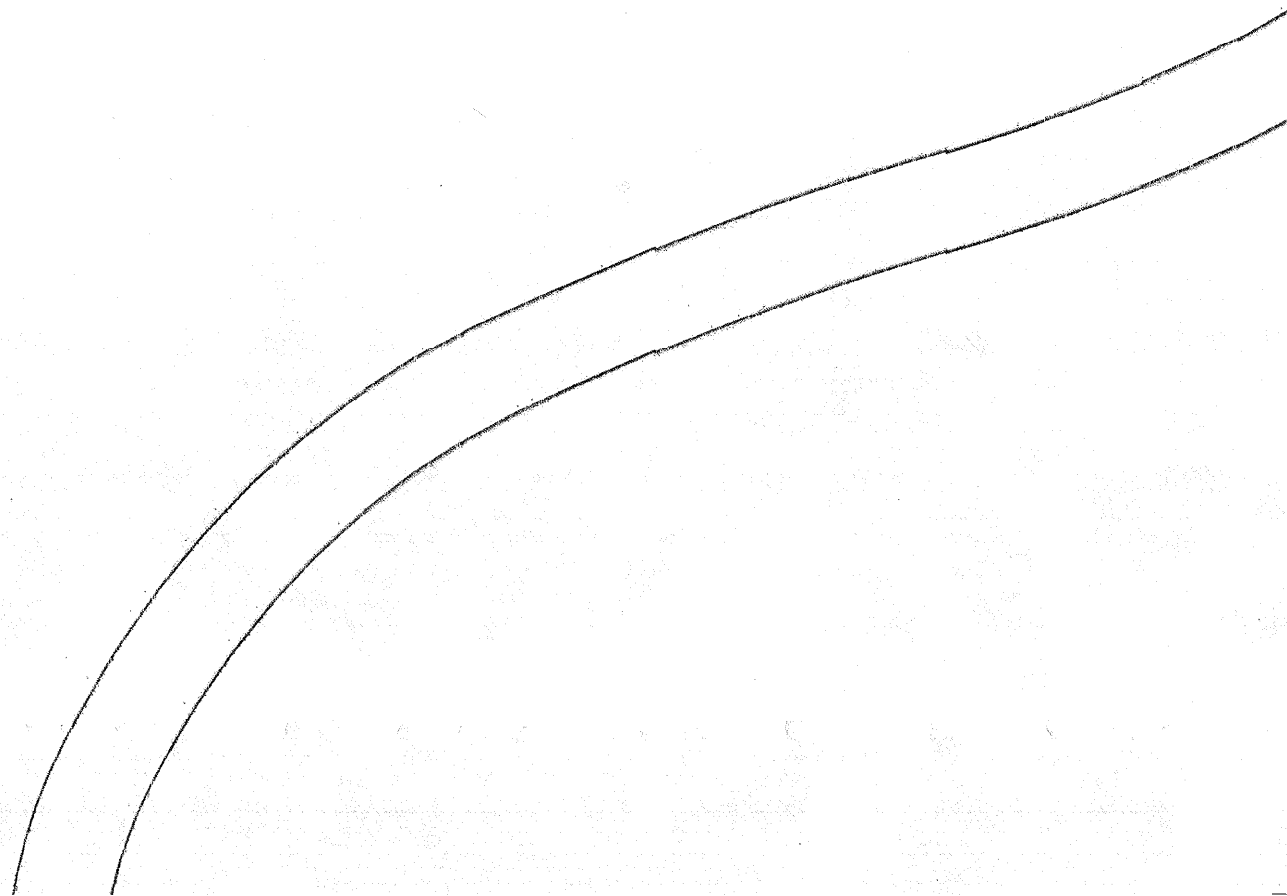

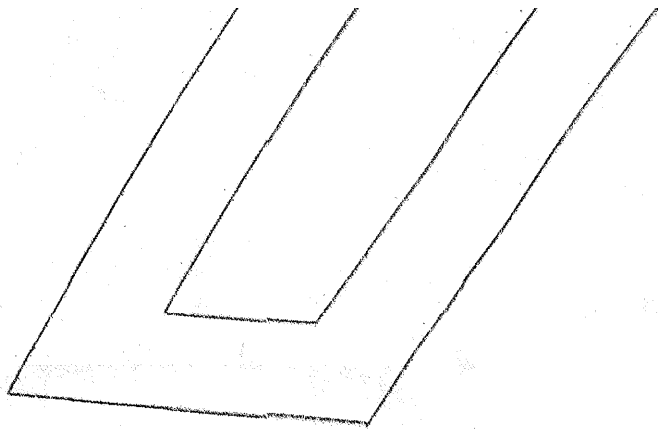

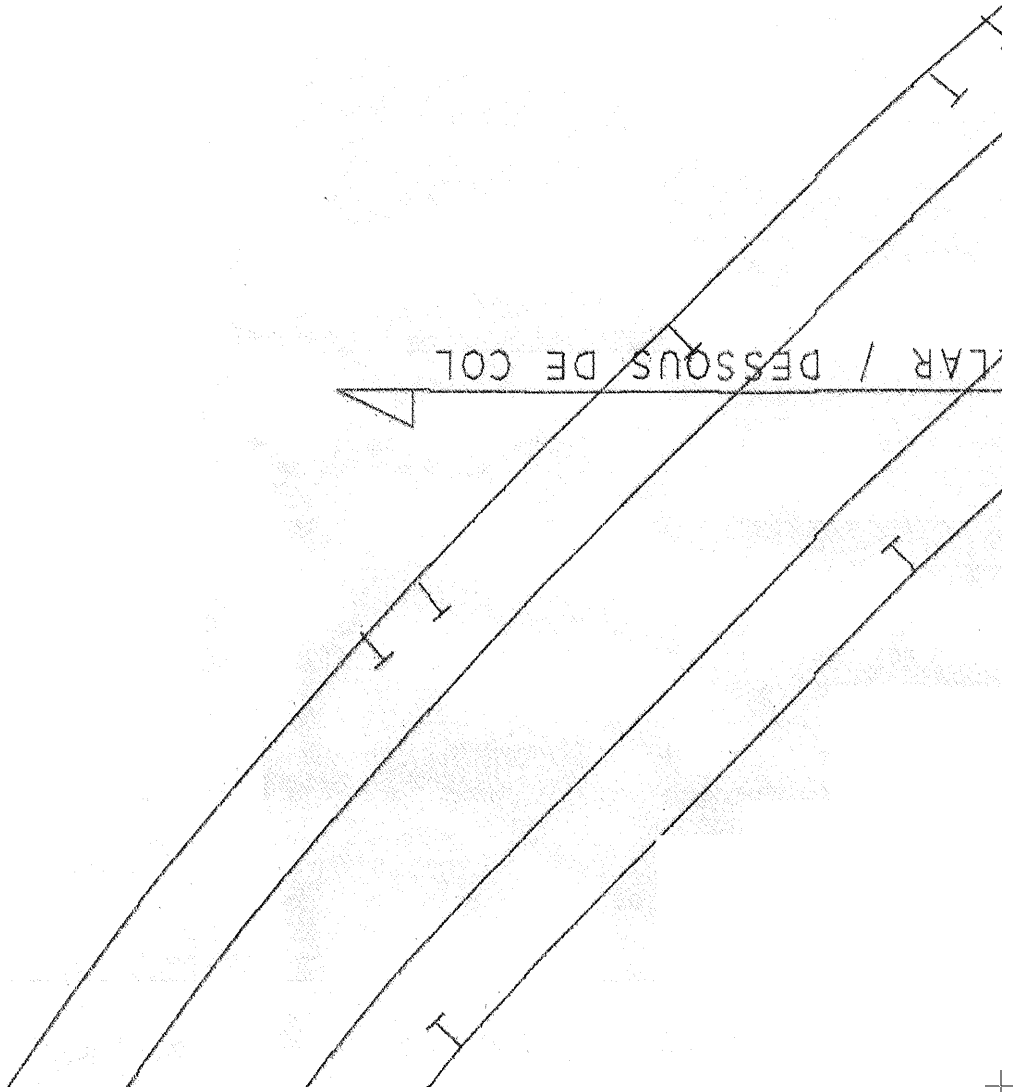
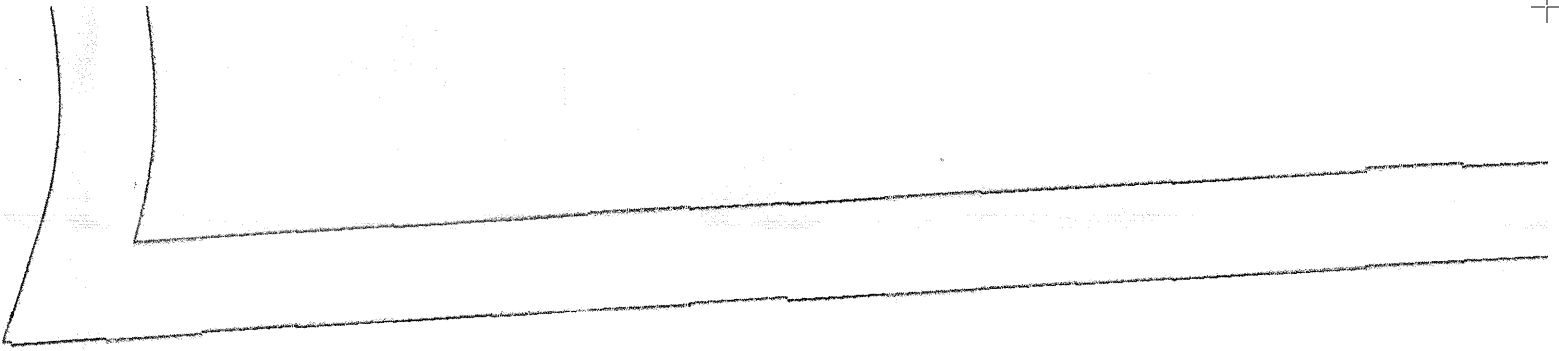

7

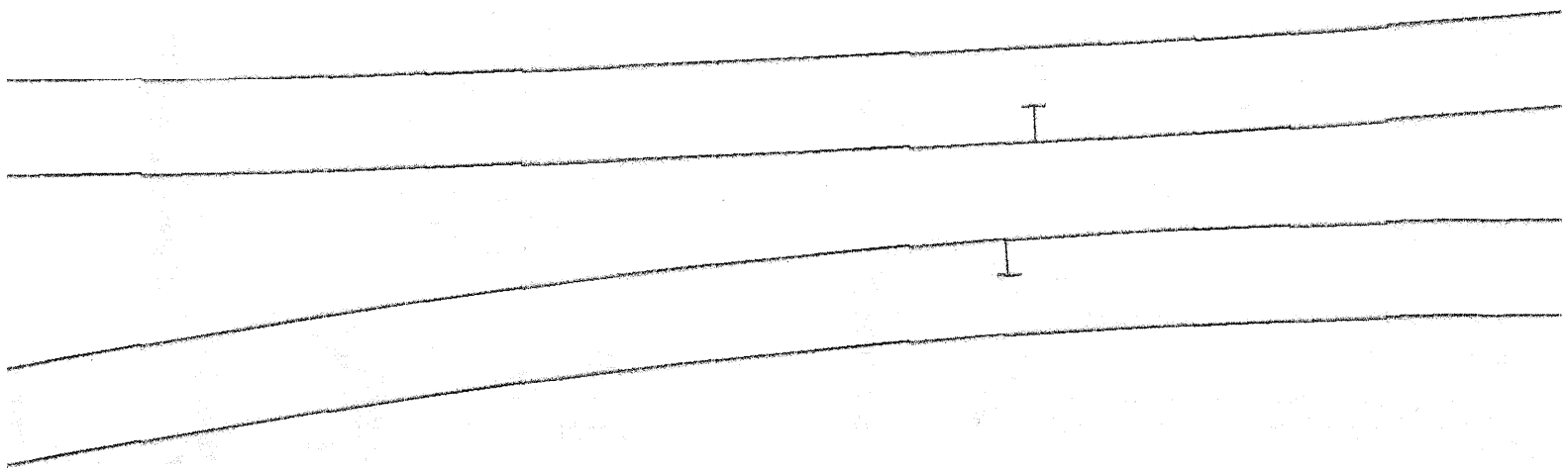

INCHES

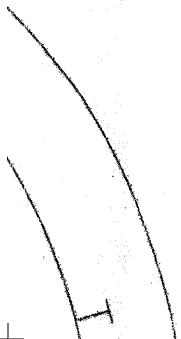

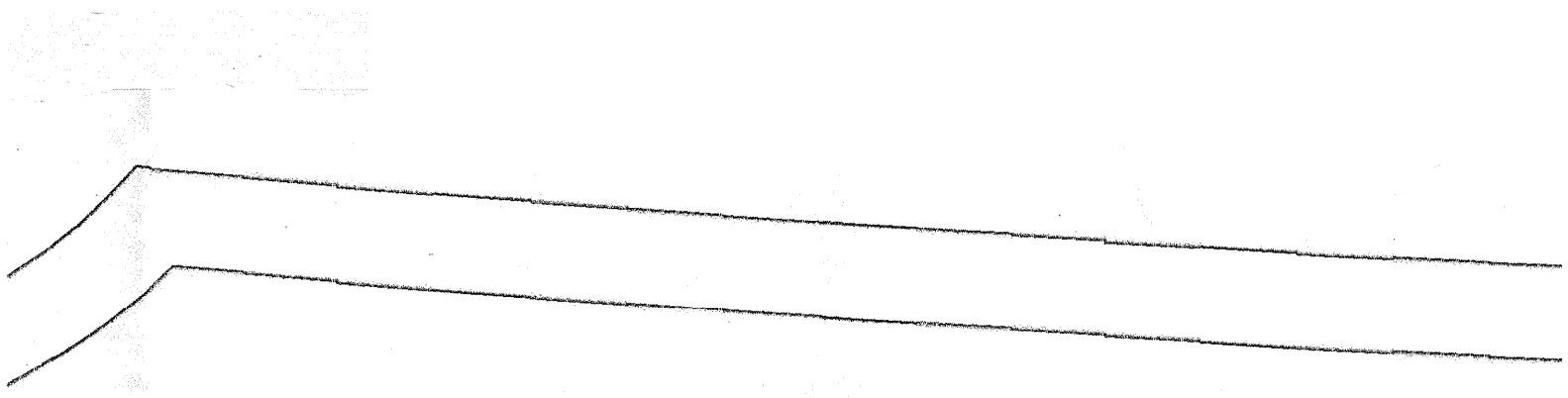



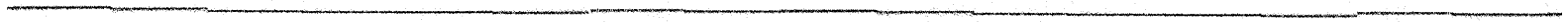
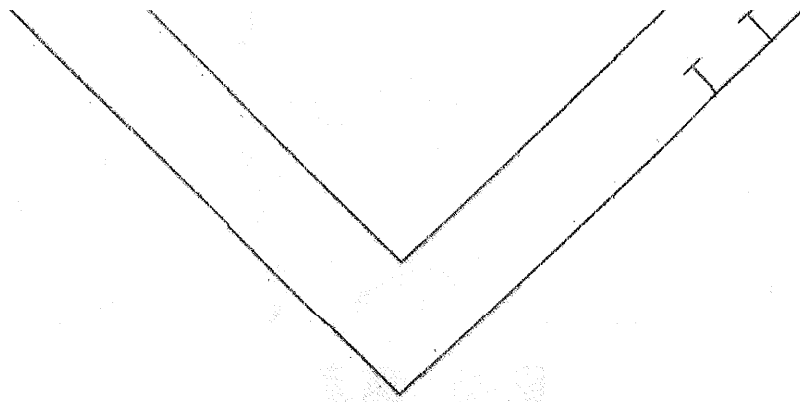

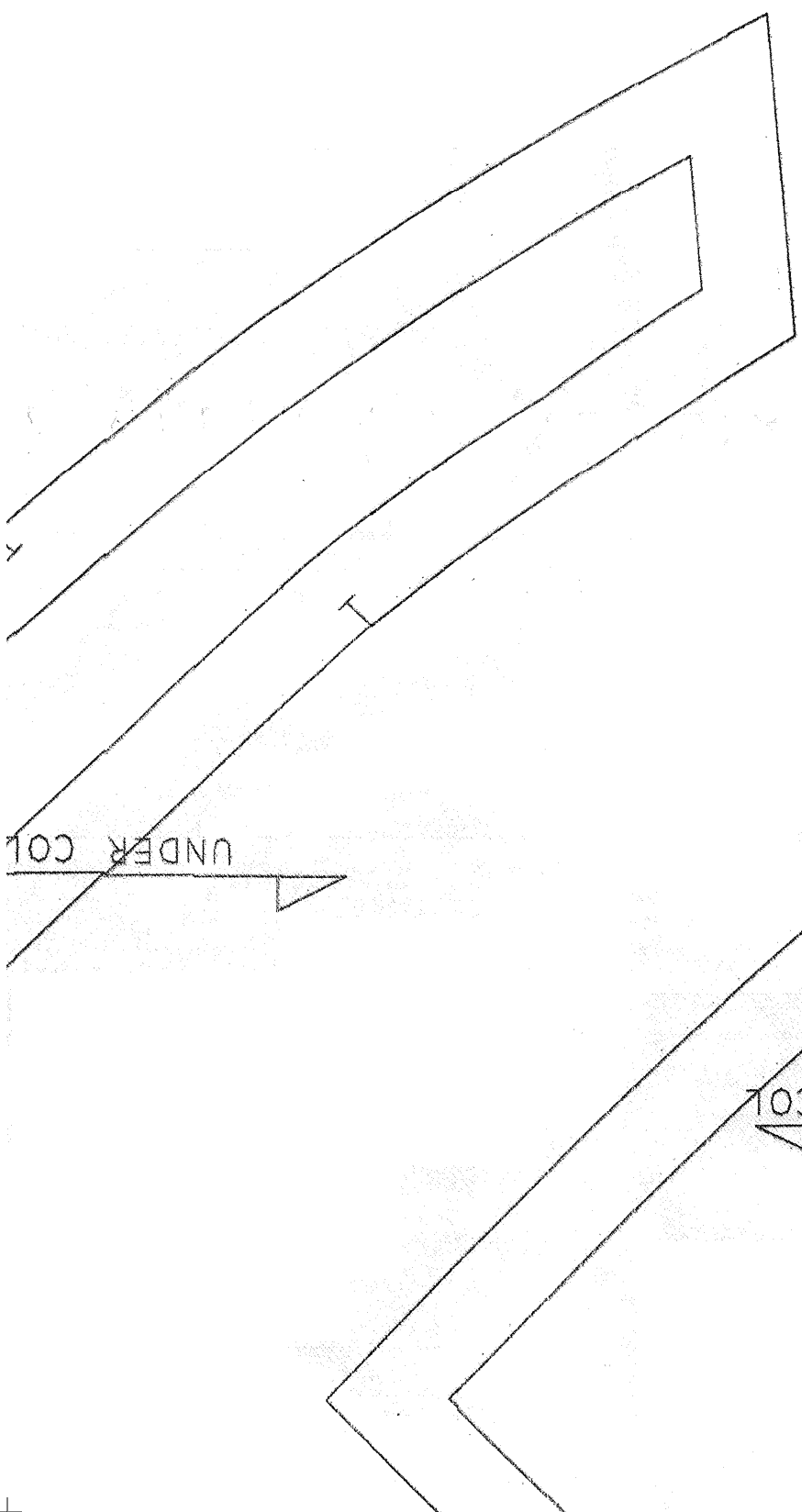
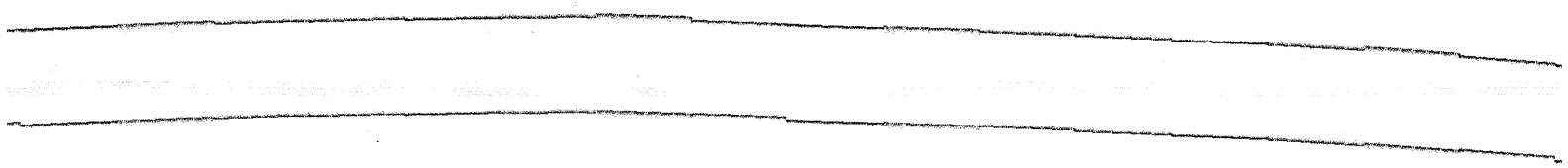

UNDER COLLAR

UNDER COLLAR / DESSOUS DE COL

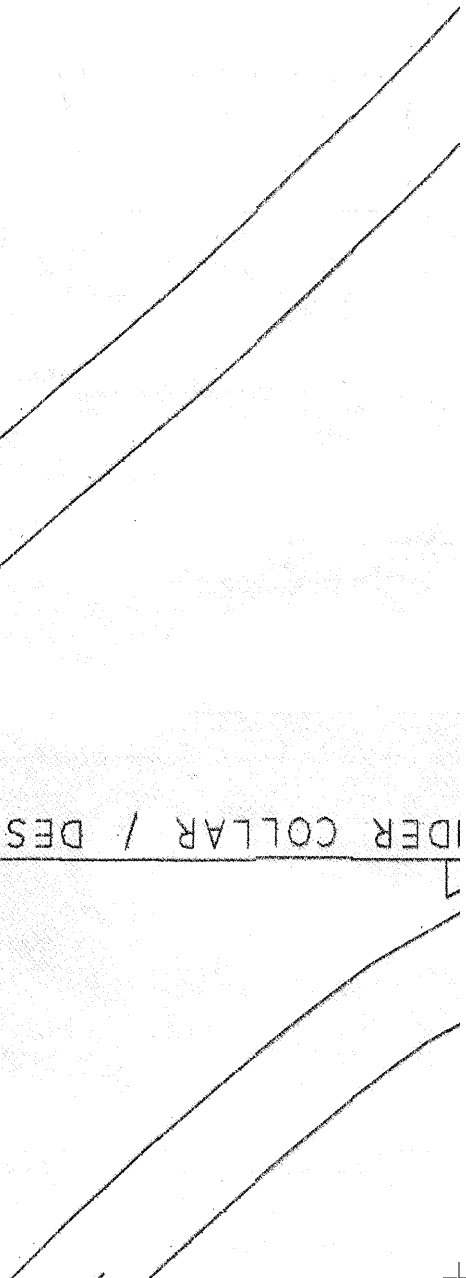

TOP CI

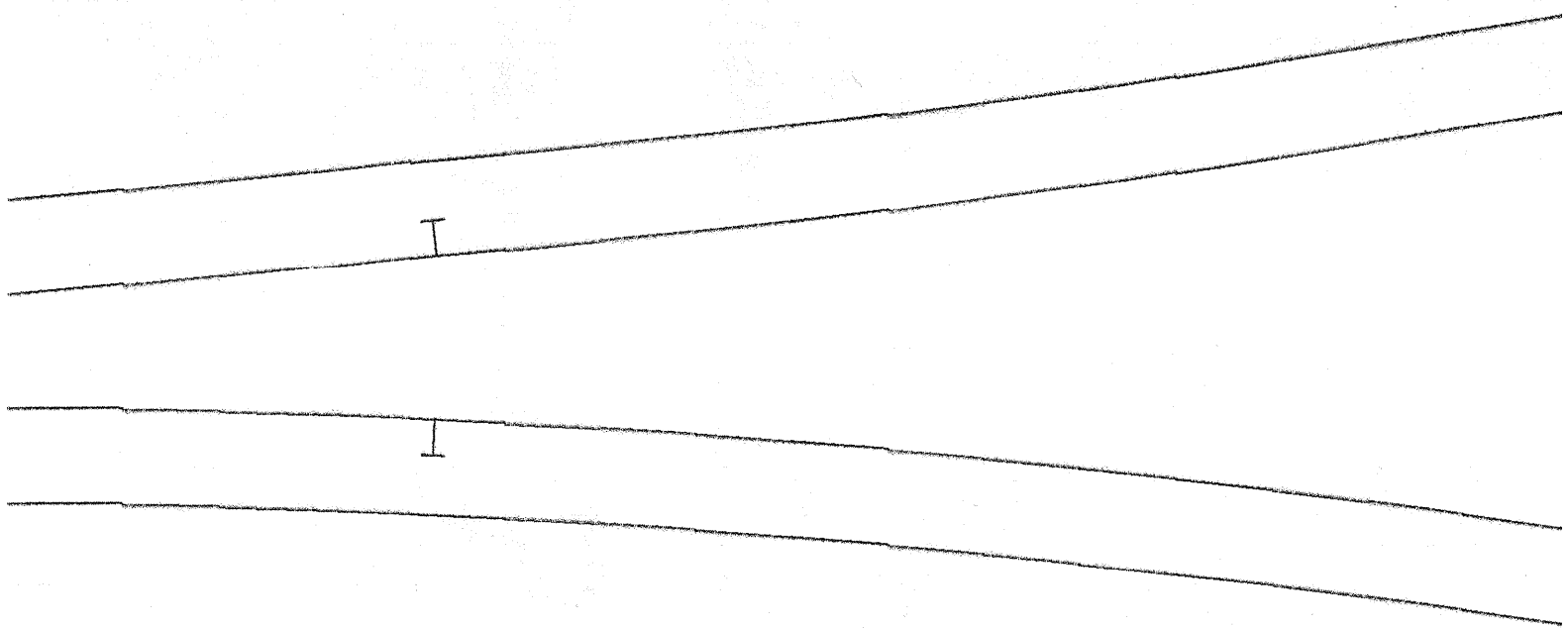

UNDER SLEVE / DESSOUS DE MA

Handwritten lines, possibly bleed-through from the reverse side of the page.

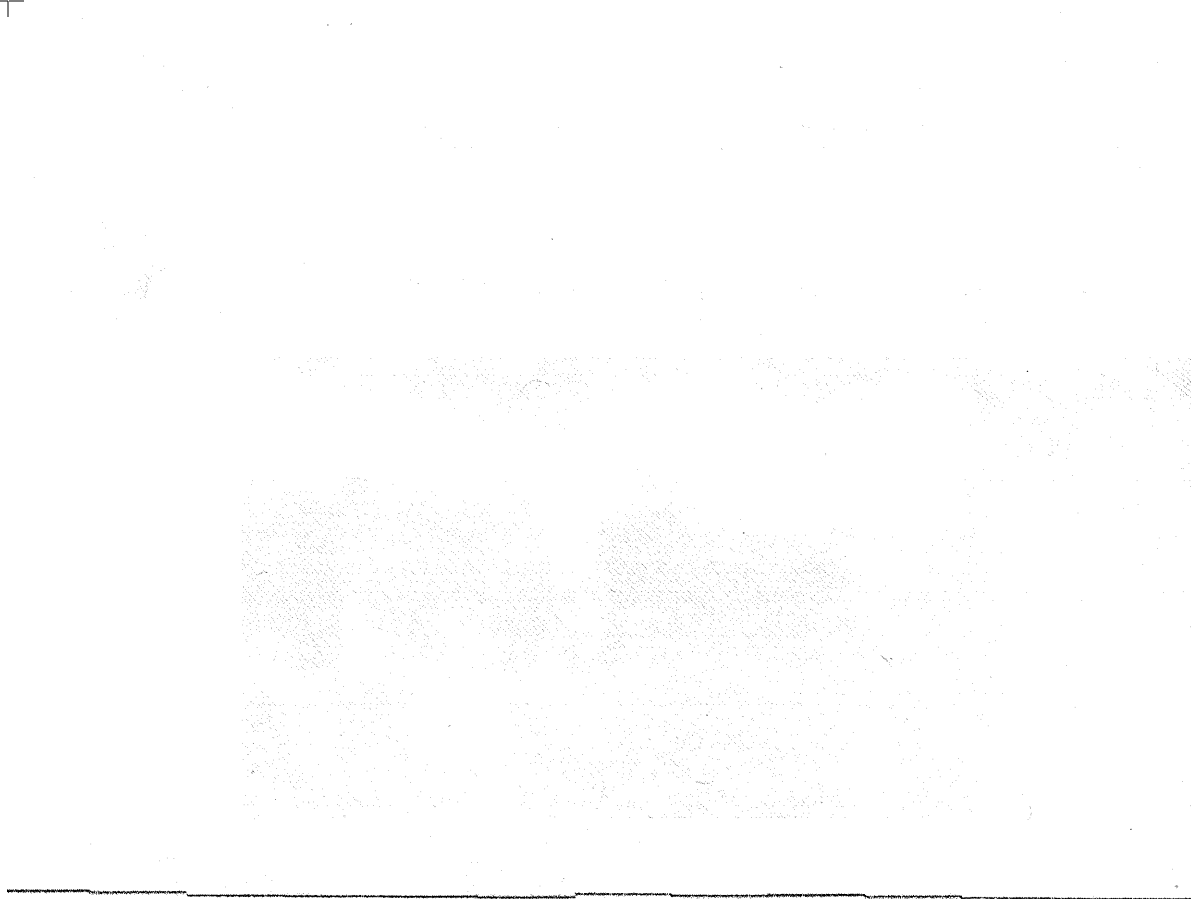

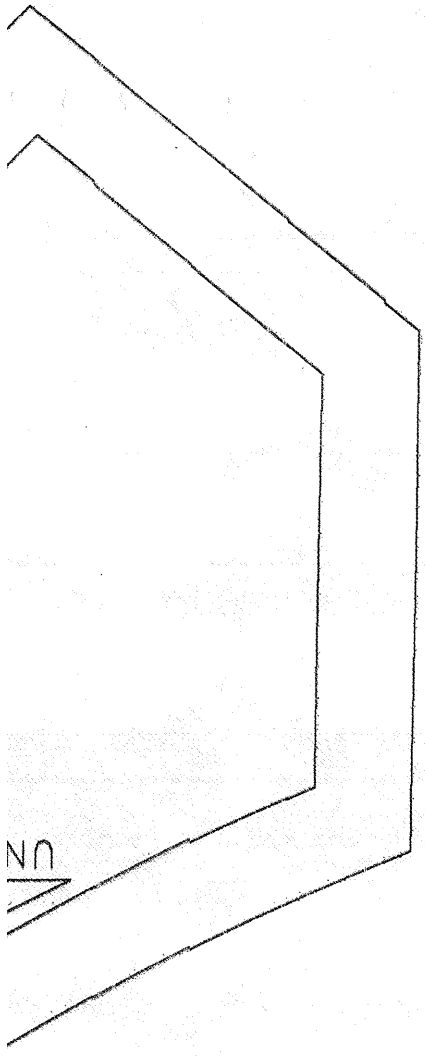
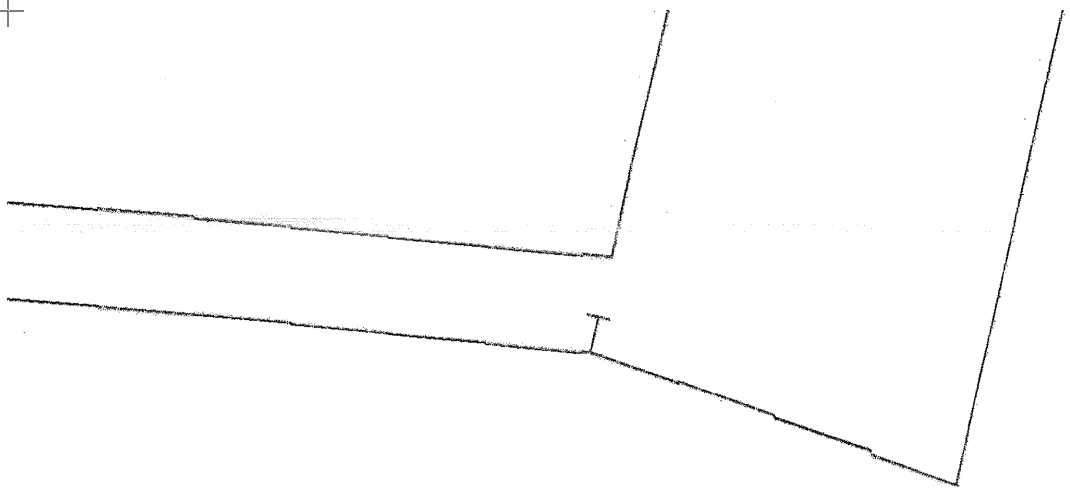

25

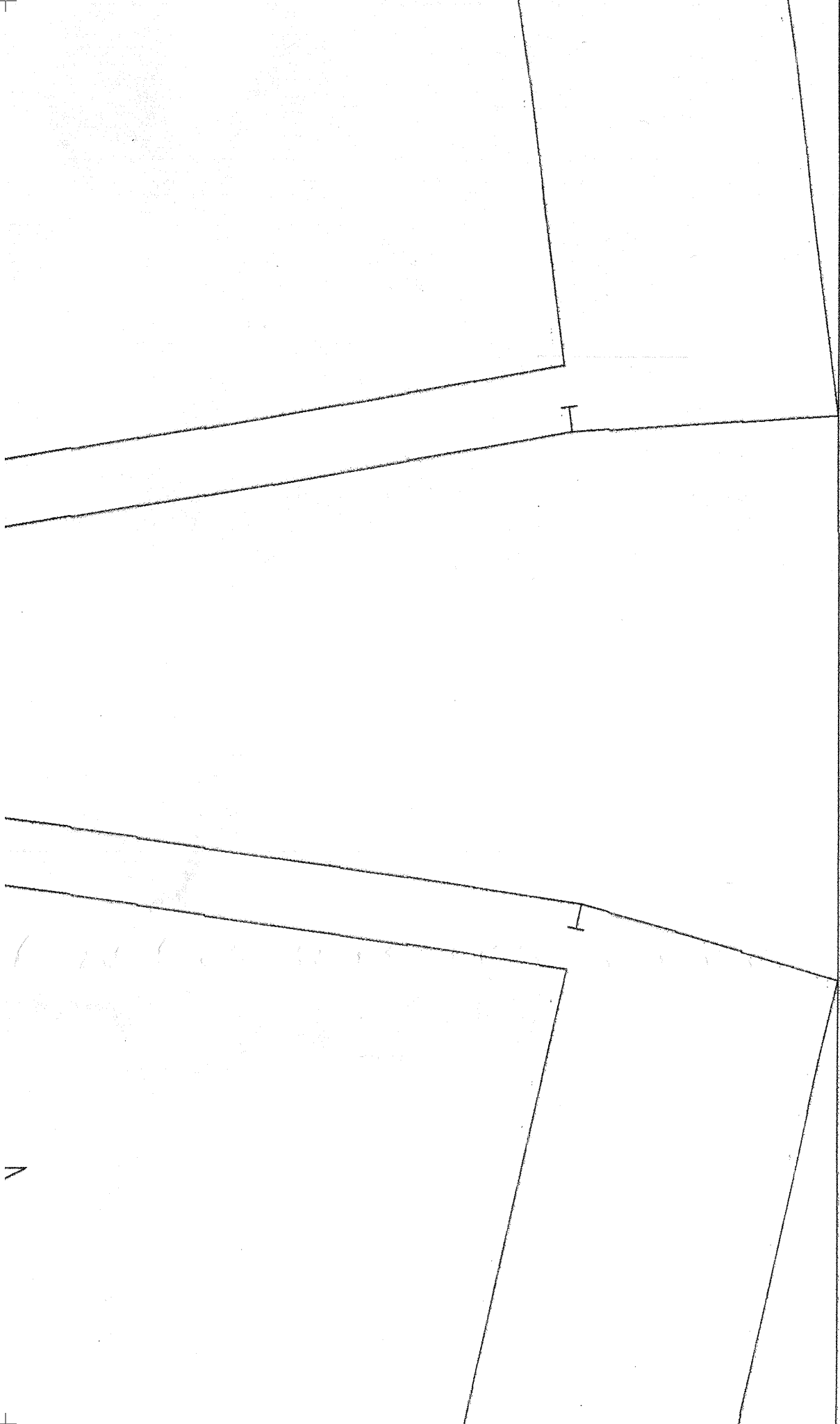

7

