

1 2 3 4 5 6 7 8 9 10

A
B
C
D
E
F

A
B
C
D
E
F

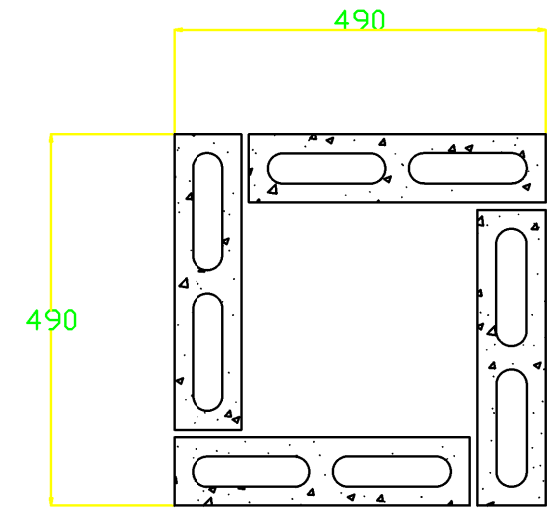
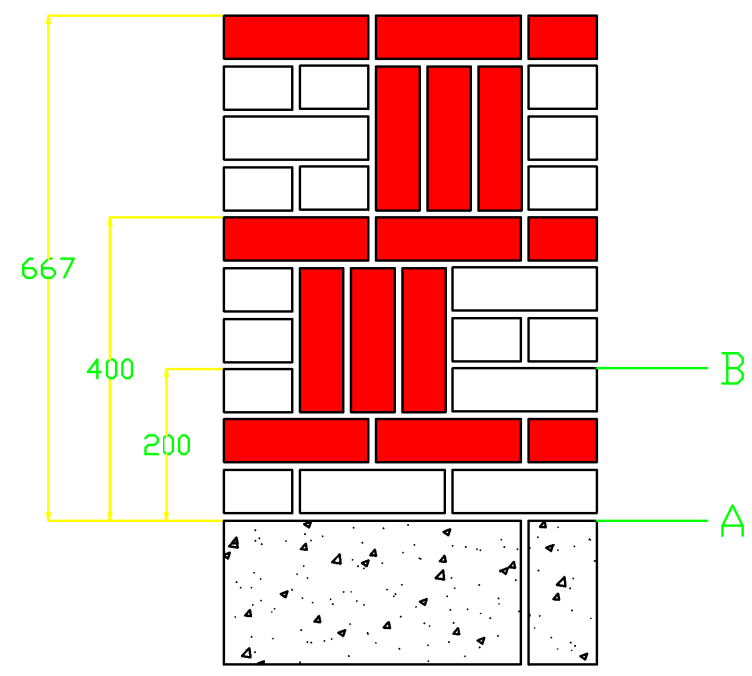

VIEW A
BLOCK LAYOUT

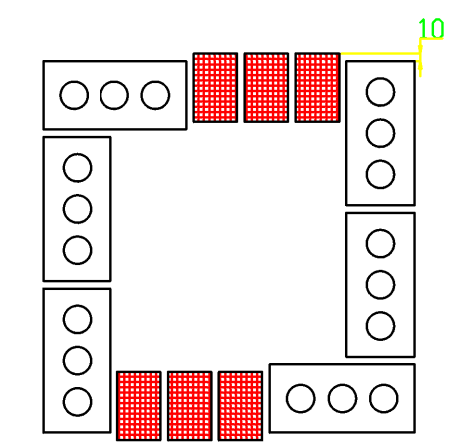

VIEW B
BRICK 3RD COURSE
LAYOUT

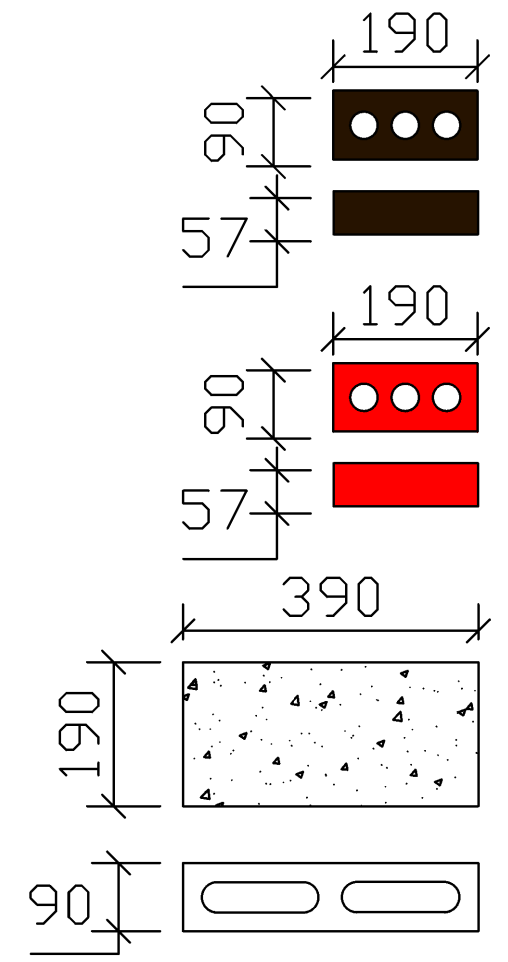

Brick #1
 --- ± 56 --- / Pieces

Brick #2
 --- ± 24 --- / Pieces

--- ± 8 --- / Pieces
 Block to build project
 and under mortar board

Ontario Skills Competition 2025
 competition
 Secondary Competition
 Ontario, Canada
 May 6th 2025

| | | | |
|--------------------------------|------------|--------------|----------------------|
| Scale: NA | 07/05/2024 | Paper: 11x17 | Comp: 20-BRICKLAYING |
| Designed & drawn: Rene Letolle | | Rev: 01 | Page: 1/1 |

1 2 3 4 5 6 7 8 9 10

| | | | | | | | | | | | |
|---|---|---|---|---|---|---|---|---|---|----|---|
| | 1 | 2 | 3 | 4 | 5 | 6 | 7 | 8 | 9 | 10 | |
| A | | | | | | | | | | | A |
| B | | | | | | | | | | | B |
| C | | | | | | | | | | | C |
| D | | | | | | | | | | | D |
| E | | | | | | | | | | | E |
| F | | | | | | | | | | | F |

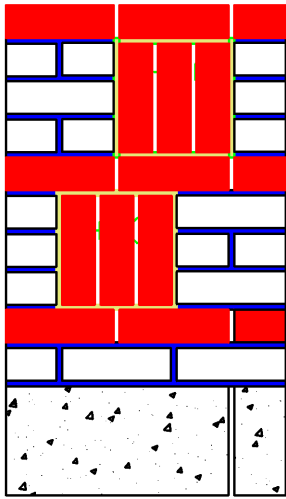

A

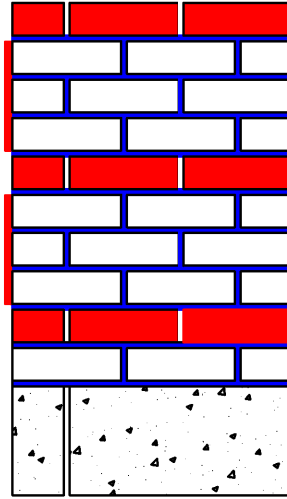

B

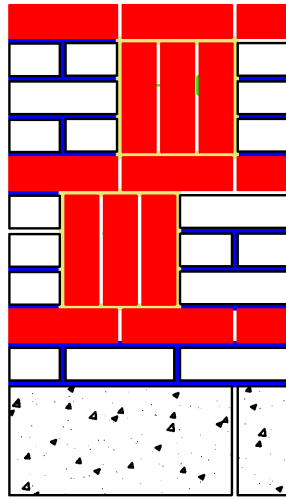

C

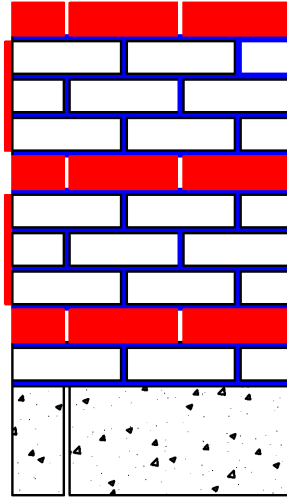

D

JOINT TYPES

FLUSH



RAKED



CONCAVE



Ontario Skills Competition 2025
competition

Secondary Competition
Ontario, Canada
May 6th 2025

Scale: NA | 07/05/2024 | Paper: 11x17 | Comp: 20-BRICKLAYING

Designed & drawn: Rene Letolle | Rev: 01 | Page: 1/1